

4" 3 in 1 downlights installation instructions

Packing List

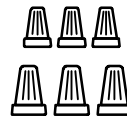
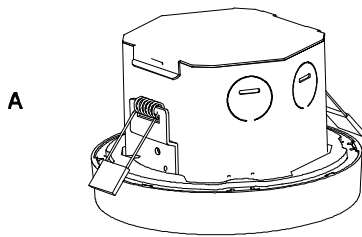

Wire nuts P2 x3
Suggest to used for flush mount installation

Wire nuts P3 x3
Suggest to used for retrofit&new recessed installation

Flush mount Downlight Packing List

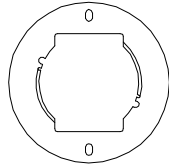

D Mounting Bracket x1

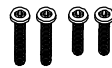

E Junction box screw#8-32 1-1/2 Screwx2

F Junction box screw#8-32 3/4 Screwx2

Retrofit recessed Downlight Packing List

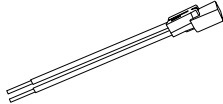

C TP24 Supply wire adapter x1

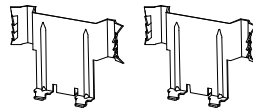

G Spring Clips x2



H M3x4 Screwx2
The screws have been installed on the downlight already.

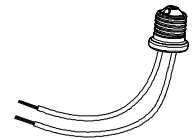

I E26 base adapter x1

New Recessed construction Downlight Packing list



H M3x4 Screwx2
The screws have been installed on the downlight already.

Installation tools

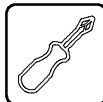

Phillips Screwdriver

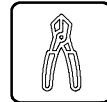

Pliers

Application scene

Suitable for 4" Retrofit downlight.

Suitable for hole cut size of 4" downlight or replace for old 4" downlight.

Suitable for surface mount. The following specification junction boxes are available when choosing surface mount.

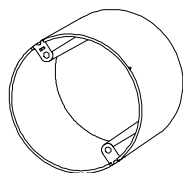

4"Round junction box
Depth≥1-1/2

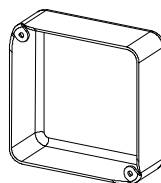

4"Square junction box
Depth≥1-1/2

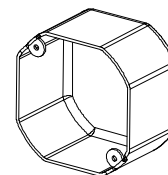

4"Octagonal junction box
Depth≥1-1/2

Flush mount instructions

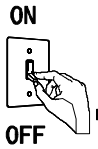

Fig.1
Turn off the power
Make sure the switch is
OFF

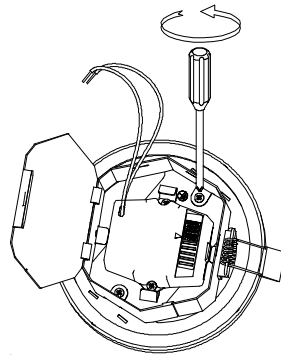

Fig.2
Remove the accessory "H" at two
side of the junction box, and then
take off the junction box.

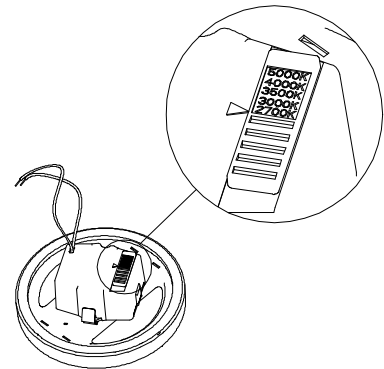

Fig.3
Toggle the button to adjust
the CCT, total 5 CCT can be
selected.

Remark:The accessory "H" can not
only be used for retrofit recessed
"G" part installation, but also can
be used for new recessed
construction installation.

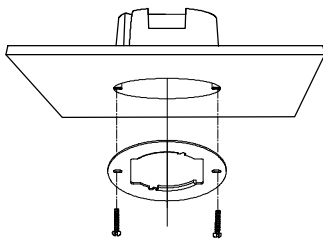

Fig.4
According to the embedded
junction box to choose
accessories "E" or "F"

Then, use screwdriver to lock
the accessory "D" to the
embedded junction box with
screw "E" or "F"

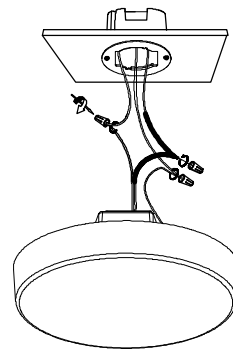

Fig.5
Firstly, choose suitable accessory "B"

Then, use accessory "B" to connect
the wire in the embedded junction
box with the wires on downlight
(black to black, white to white, green
to green)

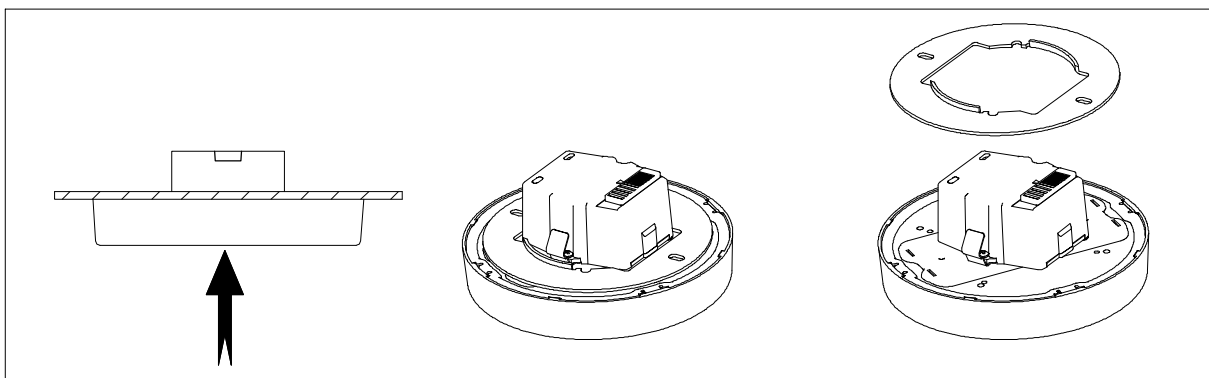

Fig.6
Push the downlight into the accessory "D". Till this step, the installation is
completed.

Retrofit recessed instructions



Fig.1
Turn off the power
Make sure the switch is OFF

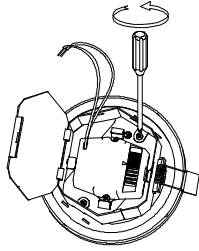

Fig.2
Remove the accessory "H"
at two side of the junction
box, and then take off the
junction box.

Remark: The accessory "H"
can not only be used for
retrofit recessed "G" part
installation, but also can
be used for new recessed
construction installation.

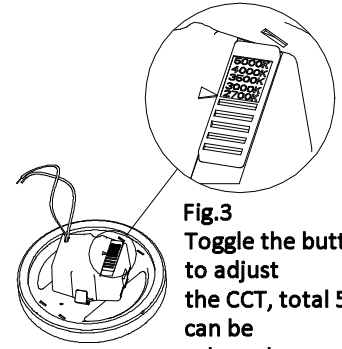

Fig.3
Toggle the button
to adjust
the CCT, total 5 CCT
can be
selected.

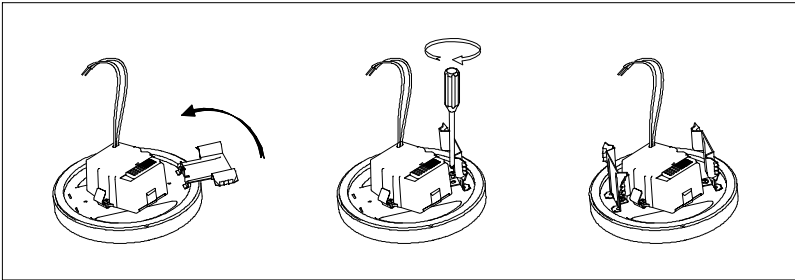

Fig.4
As shown in the figure, use accessory "H"
to fix accessory "G" on the downlight.
The tool used here is a Phillips
screwdriver

Method 1. Use E26 base adapter

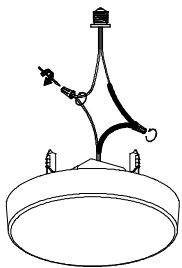

Fig.5
Firstly, choose suitable accessory "B"

Then, use accessory "B" to connect
the wire on E26 with the wires on
downlight (black to black, white to
white, if you got Earth in the
embedded housing, then make it
green to green)

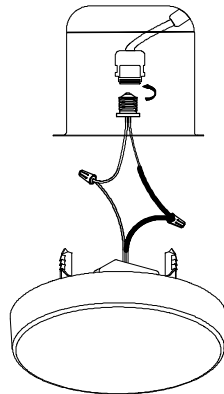

Fig.6
Install the accessory "I" into the embedded
housing as shown in the picture

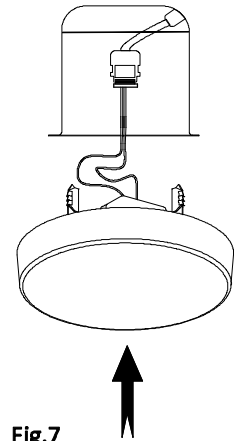

Fig.7
Push the downlight into
the embedded housing by
accessory "G". Till this
step, the installation is
completed.

Method 2. Use TP24 Supply wire adapter

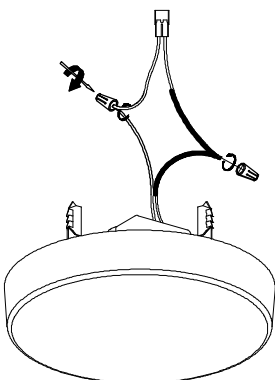

Fig.5
Firstly, choose suitable accessory "B"

Then, use accessory "B" to connect with the accessory
"C" directly.

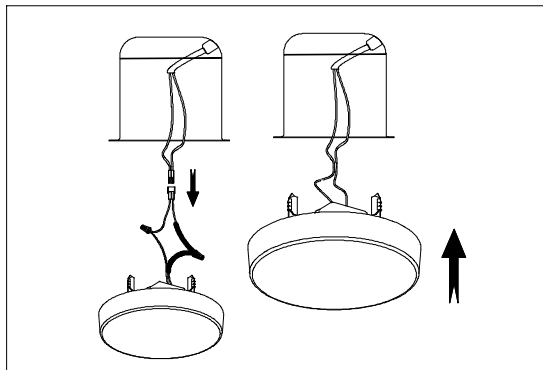

Fig.6
Connect the accessory "C" with the TP24 which is already in the
embedded housing.
Then, push the downlight into the embedded housing by accessory
"G". Till this step, the installation is completed.
It should be noted that the accessory "G" need to be pinched and
stuck to the internal fittings of the housing.

New Recessed construction instructions



Fig.1
Turn off the power
Make sure the switch is
OFF

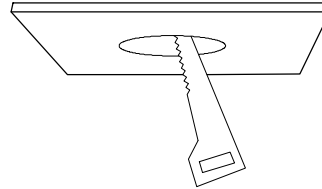

Fig.2
Use tools to cut holes in the ceiling
(4inch:108CM 6/8inch: 160CM)

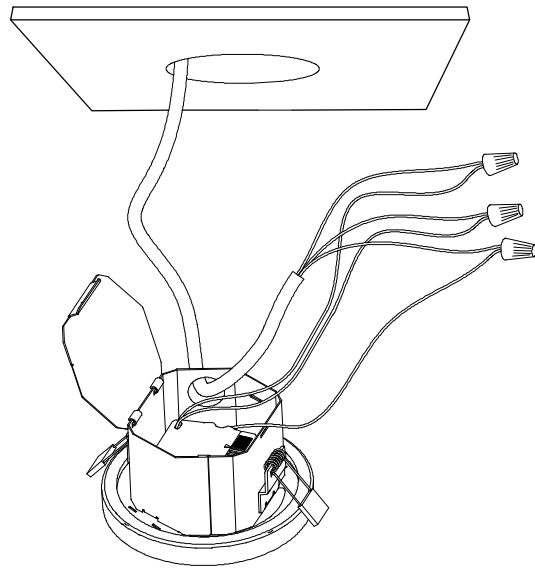
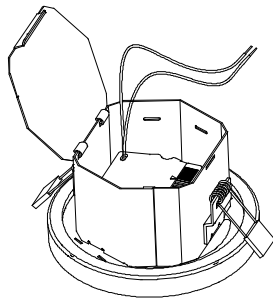

Fig.3
Choose suitable accessory "B"

Use accessory "B" to connect the wires in the embedded housing with the wires in the junction box(black to black,white to white,green to green)

New Recessed construction instructions

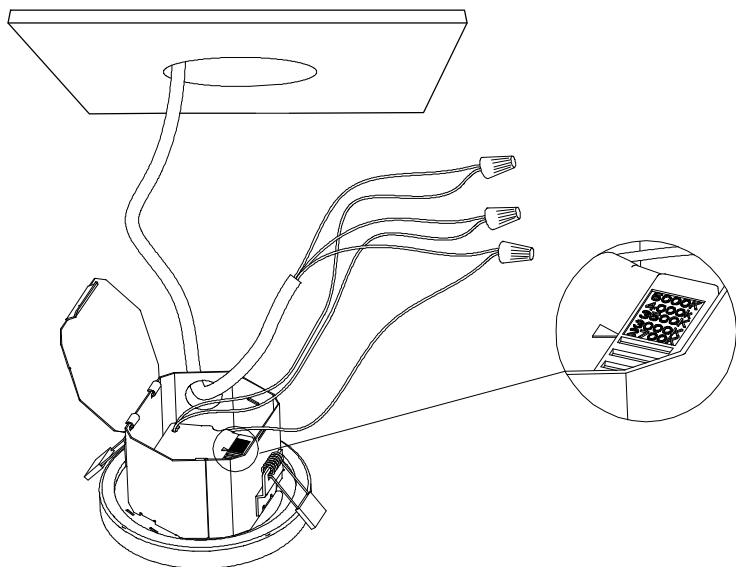

Fig.4
Toggle the button to adjust the CCT, total 5 CCT can be selected.

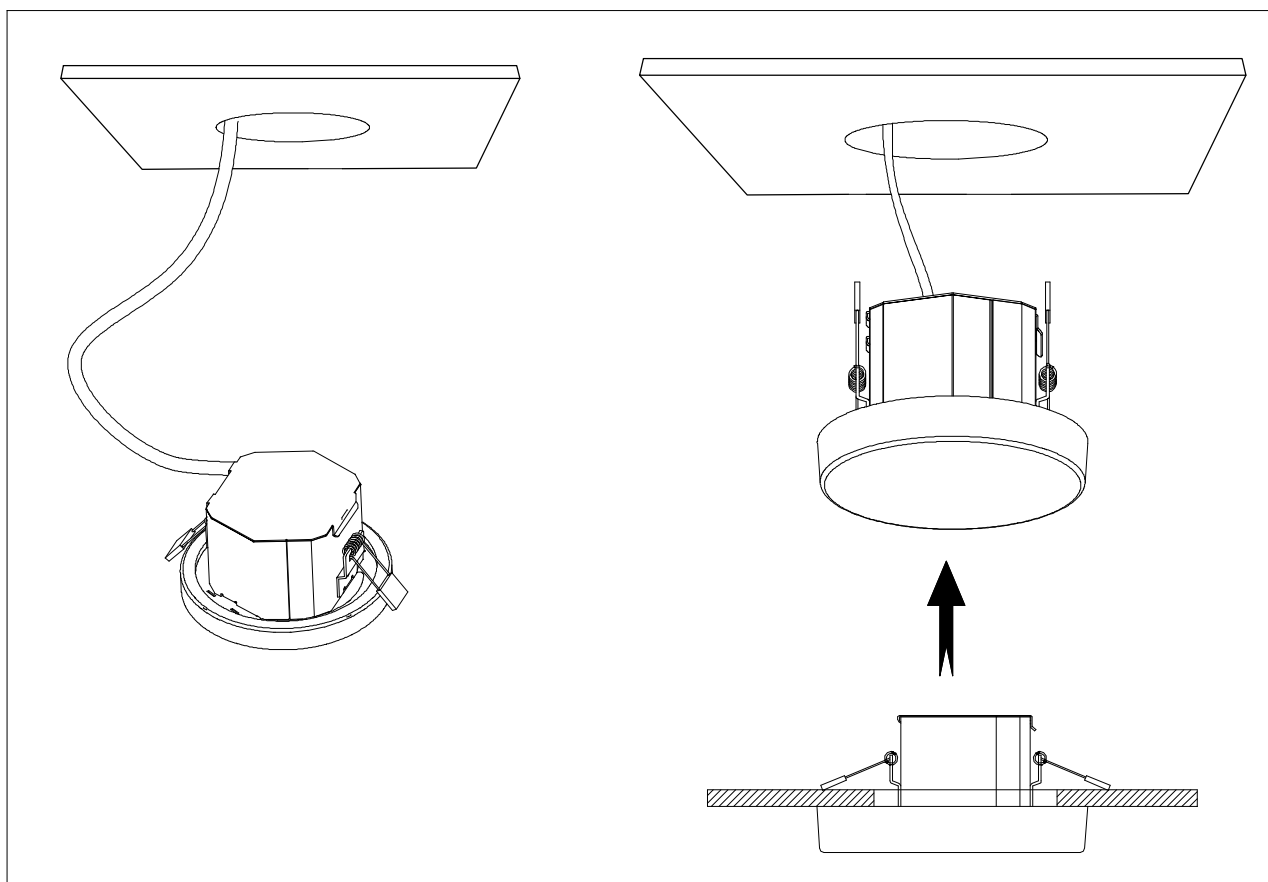

Fig.5
Push the downlight into the embedded housing by spring clips. Till this step, the installation is completed.